

MOC
Veranstaltungszentrum
München

Lilienthalallee 40
D-80939 München
www.moc-muenchen.de





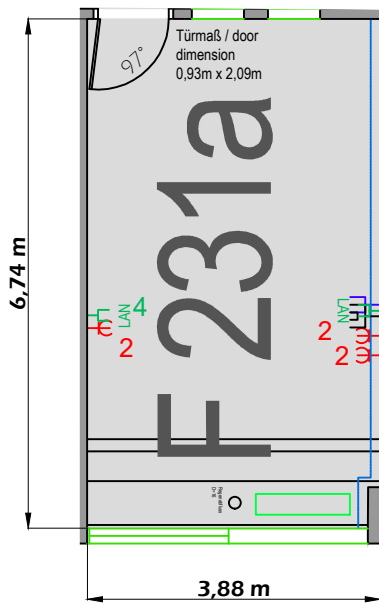
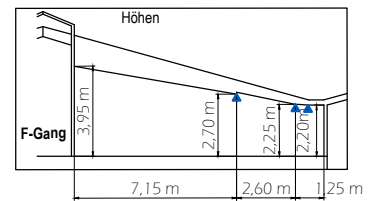

ATRIUM 4, Sektor F
2.OG / 2nd floor
Raum / room F 231a
26 m²



F-Gang /
F-aisle



Maßstab / scale: 1:100

<p>Bauhöhe / <i>construction height:</i></p> <p>Bodenbelastbarkeit / <i>floor load limit:</i></p> <p>Teppichbelag / <i>carpet covering:</i></p> <p>Deckeninstallation / <i>ceiling installation:</i></p>	<p>Die maximale Bauhöhe in den Showrooms richtet sich nach der jeweiligen Deckenhöhe. Der Mindestabstand zur Decke muss 60 cm betragen (Abhängungen sind nicht möglich). /</p> <p>The maximum construction height depends on the respective ceiling height. The minimum clearance required to the ceiling is 60 cm (ceiling suspensions are not possible).</p> <p>max. 500 kg / m²</p> <p>grau gemustert / grey patterned</p> <p>Sprinkleranlage, Leuchtstoffröhren sprinkler system, fluorescent tubes</p>	<p> Klimagerät / <i>air conditioner</i></p> <p> Glasfront / <i>glass front</i></p> <p> Schuko-Steckdosen / <i>shockproof safety sockets</i></p> <p> Installationskanal / <i>installation channel</i> (7 cm Breite / 7 cm wide)</p> <p>Auf Bestellung / <i>on demand:</i></p> <p> Breitbandkabelanschluss / <i>broadband cable connection</i></p> <p> Telefon-Anschluss / <i>telephone connection</i></p> <p> Netzwerk-Anschluss / <i>network connection</i></p>
--	--	--

Dieser Plan ist ausschließlich für die Lage der Mietfläche im Objekt verbindlich. Alle Angaben sind ohne Gewähr. Für Einbauten sind die Maße vor Ort zu nehmen.
This map is only mandatory concerning the location of the rented room. No responsibility is taken for the correctness of this information. For any installations please measure on-site.